



SCHALTGERÄTE

Komplett-Typen Baureihe MN Complete types Series MN

Haupt-Schalter mit UnterSPannungsAuslösung

mit Not-Aus-Funktion und UnterSPannungsAuslösung
in der Ausführung: Griff / Front: rot/gelb = rt/ge
ohne Not-Aus-Funktion mit UnterSPannungsAuslösung
in der Ausführung: Griff / Front: schwarz/grau = sw/gr

Main-Switches with UnderVoltageRelease

with Emergency-Off-function and UnderVoltageRelease
handle/front in red/yellow rd/ye
without Emergency-Off-function and UnderVoltageRelease
handle/front in black/grey bk/gr



Fronteinbau mit 2-Lochbefestigung Vorhängeschlossperre für 3 Vorhängeschlösser

Griff in rot/gelb rt/ge
oder schwarz/grau = sw/gr

2-hole front mounting with lockout handle for 3 padlocks

handle/front plate red/yellow rd/ye
or black/grey bk/gr

Abmessungen / Dimensions
Bauform / Design: 1504/1505

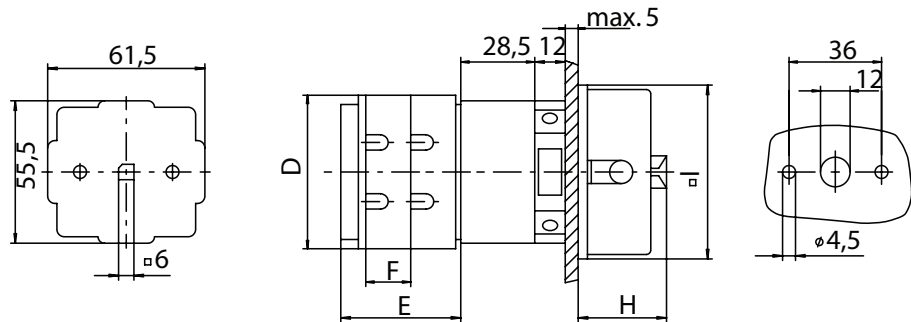

Baureihe Series	Abmessungen (mm) Dimensions (mm)																	
	D	E	F	H	I													
151	49	36	12,5	32	66													
251	62	38	12,5	32	66													
451	72	47	17,5	32	66													

Schaltprogramm Contact arrangement	Dauerstrom I_{th} Rated Uninterrupted current I_{th} A	Leistung Rating AC 3 kW	Leistung Rating AC 23A kW	Baureihe Series	Griff/ Frontschild handle/ front plate	Typ Type	Best.Nr. Part #
2-polig USPA 230V AC 2-pole UVR 230V AC 	32	7,5	11	151	rt/ge rd/ye	A 151/1002.1504-U230/N-S	MZ 23 019
	32	7,5	11	151	sw/gr bk/gr	A 151/1002.1505-U230/N-S	MZ 23 022
	40	11	15	251	rt/ge rd/ye	A 251/1002.1504-U230/N-S	MZ 23 020
	40	11	15	251	sw/si bk/si	A 251/1002.1505-U230/N-S	MZ 23 023
	63	18,5	22	451	rt/ge rd/ye	A 451/1002.1504-U230/N-S	MZ 23 021
	63	18,5	22	451	sw/gr bk/gr	A 451/1002.1505-U230/N-S	MZ 23 024
3-polig USPA 230V AC 3-pole UVR 230V AC 	32	7,5	11	151	rt/ge rd/ye	A 151/1008.1504-U230/N-S	MZ 23 031
	32	7,5	11	151	sw/gr bk/gr	A 151/1008.1505-U230/N-S	MZ 23 034
	40	11	15	251	rt/ge rd/ye	A 251/1008.1504-U230/N-S	MZ 23 032
	40	11	15	251	sw/si bk/si	A 251/1008.1505-U230/N-S	MZ 23 035
	63	18,5	22	451	rt/ge rd/ye	A 451/1008.1504-U230/N-S	MZ 23 033
	63	18,5	22	451	sw/gr bk/gr	A 451/1008.1505-U230/N-S	MZ 23 036
3-polig USPA 400V AC 3-pole UVR 400V AC 	32	7,5	11	151	rt/ge rd/ye	A 151/1008.1504-U400/2S	MZ 23 037
	32	7,5	11	151	sw/gr bk/gr	A 151/1008.1505-U400/2S	MZ 23 040
	40	11	15	251	rt/ge rd/ye	A 251/1008.1504-U400/2S	MZ 23 038
	40	11	15	251	sw/si bk/si	A 251/1008.1505-U400/2S	MZ 23 041
	63	18,5	22	451	rt/ge rd/ye	A 451/1008.1504-U400/2S	MZ 23 039
	63	18,5	22	451	sw/gr bk/gr	A 451/1008.1505-U400/2S	MZ 23 042
4-polig USPA 230V AC 4-pole UVR 230V AC 	32	7,5	11	151	rt/ge rd/ye	A 151/1004.1504-U230/N-S	MZ 23 043
	32	7,5	11	151	sw/gr bk/gr	A 151/1004.1505-U230/N-S	MZ 23 046
	40	11	15	251	rt/ge rd/ye	A 251/1004.1504-U230/N-S	MZ 23 044
	40	11	15	251	sw/si bk/si	A 251/1004.1505-U230/N-S	MZ 23 047
	63	18,5	22	451	rt/ge rd/ye	A 451/1004.1504-U230/N-S	MZ 23 045
	63	18,5	22	451	sw/gr bk/gr	A 451/1004.1505-U230/N-S	MZ 23 048
4-polig USPA 400V AC 4-pole UVR 400V AC 	32	7,5	11	151	rt/ge rd/ye	A 151/1004.1504-U400/2S	MZ 23 049
	32	7,5	11	151	sw/gr bk/gr	A 151/1004.1505-U400/2S	MZ 23 052
	40	11	15	251	rt/ge rd/ye	A 251/1004.1504-U400/2S	MZ 23 050
	40	11	15	251	sw/si bk/si	A 251/1004.1505-U400/2S	MZ 23 053
	63	18,5	22	451	rt/ge rd/ye	A 451/1004.1504-U400/2S	MZ 23 051
	63	18,5	22	451	sw/gr bk/gr	A 451/1004.1505-U400/2S	MZ 23 054



SCHALTGERÄTE

Komplett-Typen Baureihe MN

Complete types Series MN

Ein-Aus-Schalter
mit **UnterSPannungsAuslösung**

On-Off-Switches
with *UnderVoltageRelease*



Fronteinbau mit
2-Lochbefestigung

Griff / Frontplatte
schwarz/silber sw/si

2-hole front mounting

handle/front plate in
black/silver bk/si

Abmessungen / Dimensions
Bauform / Design: 0401

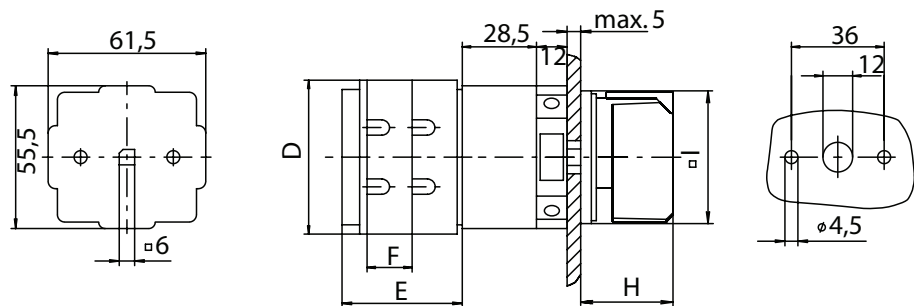

Baureihe Series	Abmessungen (mm) Dimensions (mm)				
	D	E	F	H	I
151	49	36	12,5	32	66
251	62	38	12,5	32	66
451	72	47	17,5	32	66

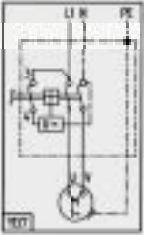
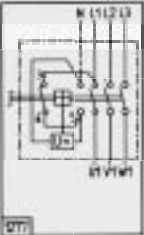
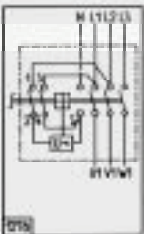
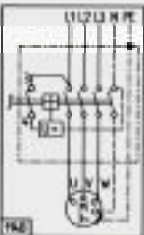
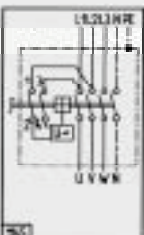
Schaltprogramm Contact arrangement	Dauerstrom I_{th} Rated Uninterrupted current I_{th} A	Leistung Rating AC 3 kW	Leistung Rating AC 23A kW	Baureihe Series	Griff/ Frontschild handle/ front plate	Typ Type	Best.Nr. Part #
2-polig USPA 230V AC 2-pole UVR 230V AC 	32	7,5	11	151	sw/si bk/si	A 151/1002.0401-U230/N-S	MZ 23 001
	40	11	15	251	sw/si bk/si	A 251/1002.0401-U230/N-S	MZ 23 002
	63	18,5	22	451	sw/si bk/si	A 451/1002.0401-U230/N-S	MZ 23 003
3-polig USPA 230V AC 3-pole UVR 230V AC 	32	7,5	11	151	sw/si bk/si	A 151/1008.0401-U230/N-S	MZ 23 007
	40	11	15	251	sw/si bk/si	A 251/1008.0401-U230/N-S	MZ 23 008
	63	18,5	22	451	sw/si bk/si	A 451/1008.0401-U230/N-S	MZ 23 009
3-polig USPA 400V AC 3-pole UVR 400V AC 	32	7,5	11	151	sw/si bk/si	A 151/1008.0401-U400/2S	MZ 23 010
	40	11	15	251	sw/si bk/si	A 251/1008.0401-U400/2S	MZ 23 011
	63	18,5	22	451	sw/si bk/si	A 451/1008.0401-U400/2S	MZ 23 012
4-polig USPA 230V AC 4-pole UVR 230V AC 	32	7,5	11	151	sw/si bk/si	A 151/1004.0401-U230/N-S	MZ 23 013
	40	11	15	251	sw/si bk/si	A 251/1004.0401-U230/N-S	MZ 23 014
	63	18,5	22	451	sw/si bk/si	A 451/1004.0401-U230/N-S	MZ 23 015
4-polig USPA 400V AC 4-pole UVR 400V AC 	32	7,5	11	151	sw/si bk/si	A 151/1004.0401-U400/2S	MZ 23 016
	40	11	15	251	sw/si bk/si	A 251/1004.0401-U400/2S	MZ 23 017
	63	18,5	22	451	sw/si bk/si	A 451/1004.0401-U400/2S	MZ 23 018



SCHALTGERÄTE

Komplett-Typen Baureihe MN

Complete types Series MN

Haupt-Schalter mit UnterSPannungsAuslösung

mit Not-Aus-Funktion und UnterSPannungsAuslösung
in der Ausführung: Griff / Front: rot/gelb = rt/ge
ohne Not-Aus-Funktion mit UnterSPannungsAuslösung
in der Ausführung: Griff / Front: schwarz/grau = sw/gr

Main-Switches with UnderVoltageRelease

with Emergency-Off-function and UnderVoltageRelease
handle/front in red/yellow rd/ye
without Emergency-Off-function and UnderVoltageRelease
handle/front in black/grey bk/gr

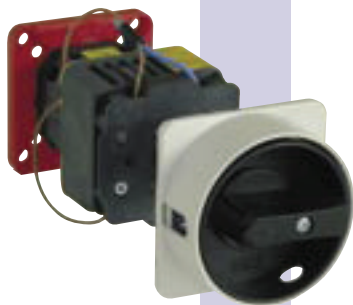

Bodeneinbau Türkupplung und Türverriegelung mit Vorhängeschlossperre für 3 Vorhängeschlösser

Griff in rot/gelb rt/ge
oder schwarz/grau = sw/gr

Base mounting Door coupling and door interlock with lockout handle for 3 padlocks

handle/front plate red/yellow rd/ye
or black/grey bk/gr

Abmessungen / Dimensions
Bauform / Design: 1580 / 1581

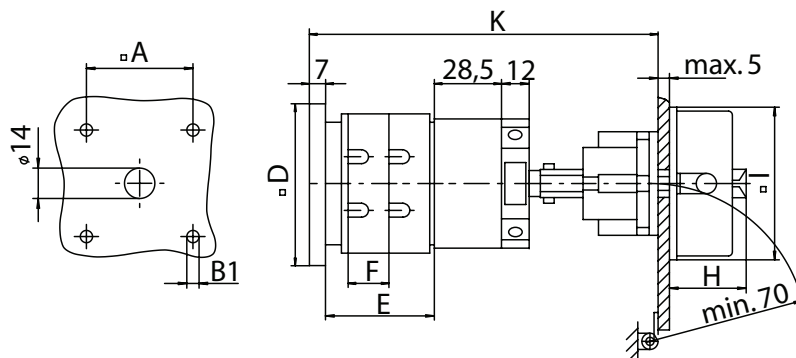

Baureihe Series	Abmessungen (mm) Dimensions (mm)							
	A	B1	D	E	F	H	I	K
151	36	4,5	49	36	12,5	32	66	132-142
251	36	4,5	62	38	12,5	32	66	135-145
451	36	4,5	72	47	17,5	32	66	143-153

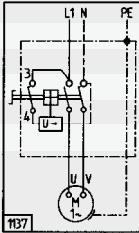
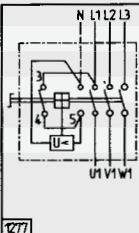
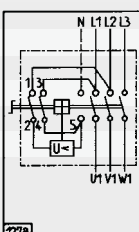
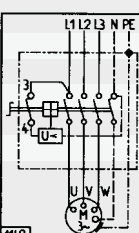
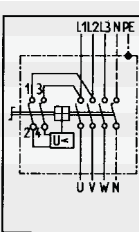
Schaltprogramm Contact arrangement	Dauerstrom I_{th} Rated Uninterrupted current I_{th} A	Leistung Rating AC 3 kW	Leistung Rating AC 23A kW	Baureihe Series	Griff/ Frontschild handle/ front plate	Typ Type	Best.Nr. Part #
2-polig USPA 230V AC 2-pole UVR 230V AC 	32	7,5	11	151	rt/ge rd/ye	A 151/1002.1580-U230/N-S	MZ 23 055
	32	7,5	11	151	sw/gr bk/gr	A 151/1002.1581-U230/N-S	MZ 23 058
	40	11	15	251	rt/ge rd/ye	A 251/1002.1580-U230/N-S	MZ 23 056
	40	11	15	251	sw/si bk/si	A 251/1002.1581-U230/N-S	MZ 23 049
	63	18,5	22	451	rt/ge rd/ye	A 451/1002.1580-U230/N-S	MZ 23 057
	63	18,5	22	451	sw/gr bk/gr	A 451/1002.1581-U230/N-S	MZ 23 060
3-polig USPA 230V AC 3-pole UVR 230V AC 	32	7,5	11	151	rt/ge rd/ye	A 151/1008.1580-U230/N-S	MZ 23 067
	32	7,5	11	151	sw/gr bk/gr	A 151/1008.1581-U230/N-S	MZ 23 070
	40	11	15	251	rt/ge rd/ye	A 251/1008.1580-U230/N-S	MZ 23 068
	40	11	15	251	sw/si bk/si	A 251/1008.1581-U230/N-S	MZ 23 071
	63	18,5	22	451	rt/ge rd/ye	A 451/1008.1580-U230/N-S	MZ 23 069
	63	18,5	22	451	sw/gr bk/gr	A 451/1008.1581-U230/N-S	MZ 23 072
3-polig USPA 400V AC 3-pole UVR 400V AC 	32	7,5	11	151	rt/ge rd/ye	A 151/1008.1580-U400/2S	MZ 23 073
	32	7,5	11	151	sw/gr bk/gr	A 151/1008.1581-U400/2S	MZ 23 076
	40	11	15	251	rt/ge rd/ye	A 251/1008.1580-U400/2S	MZ 23 074
	40	11	15	251	sw/si bk/si	A 251/1008.1581-U400/2S	MZ 23 077
	63	18,5	22	451	rt/ge rd/ye	A 451/1008.1580-U400/2S	MZ 23 075
	63	18,5	22	451	sw/gr bk/gr	A 451/1008.1581-U400/2S	MZ 23 078
4-polig USPA 230V AC 4-pole UVR 230V AC 	32	7,5	11	151	rt/ge rd/ye	A 151/1004.1580-U230/N-S	MZ 23 079
	32	7,5	11	151	sw/gr bk/gr	A 151/1004.1581-U230/N-S	MZ 23 082
	40	11	15	251	rt/ge rd/ye	A 251/1004.1580-U230/N-S	MZ 23 080
	40	11	15	251	sw/si bk/si	A 251/1004.1581-U230/N-S	MZ 23 083
	63	18,5	22	451	rt/ge rd/ye	A 451/1004.1580-U230/N-S	MZ 23 081
	63	18,5	22	451	sw/gr bk/gr	A 451/1004.1581-U230/N-S	MZ 23 084
4-polig USPA 400V AC 4-pole UVR 400V AC 	32	7,5	11	151	rt/ge rd/ye	A 151/1004.1580-U400/2S	MZ 23 085
	32	7,5	11	151	sw/gr bk/gr	A 151/1004.1581-U400/2S	MZ 23 088
	40	11	15	251	rt/ge rd/ye	A 251/1004.1580-U400/2S	MZ 23 086
	40	11	15	251	sw/si bk/si	A 251/1004.1581-U400/2S	MZ 23 089
	63	18,5	22	451	rt/ge rd/ye	A 451/1004.1580-U400/2S	MZ 23 087
	63	18,5	22	451	sw/gr bk/gr	A 451/1004.1581-U400/2S	MZ 23 090



SCHALTGERÄTE

Komplett-Typen Baureihe MN

Complete types Series MN

Haupt-Schalter mit UnterSPannungsAuslösung

mit Not-Aus-Funktion und UnterSPannungsAuslösung
im Kunststoffgehäuse
in der Ausführung: Griff / Front: rot/gelb = rt/ge
ohne Not-Aus-Funktion mit UnterSPannungsAuslösung
in der Ausführung: Griff / Front: schwarz/grau = sw/gr

Main-Switches with UnderVoltageRelease

with Emergency-Off-function and UnderVoltageRelease in
plastic enclosure
handle/front in red/yellow rd/ye
without Emergency-Off-function and UnderVoltageRelease
handle/front in black/grey bk/gr



mit Vorhängeschlossperre für 3 Vorhängeschlösser

Griff in rot/gelb rt/ge
oder schwarz/grau = sw/gr

with lockout handle for 3 padlocks

handle/front plate red/yellow rd/ye
or black/grey bk/gr

Abmessungen / Dimensions
Bauform / Design: I2H1850 / 1851; I3H1850 / 1851

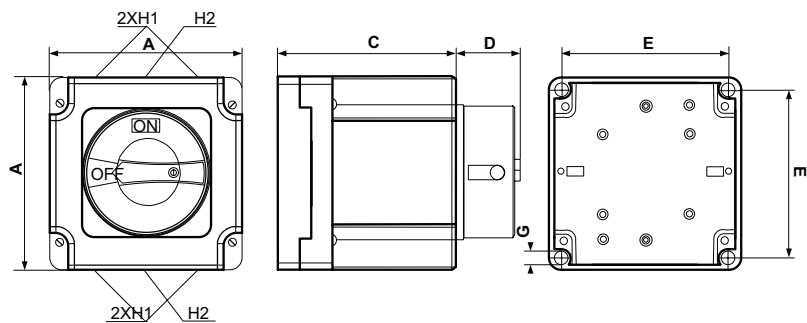

Baureihe Series	Abmessungen (mm) Dimensions (mm)							
	A	C	D	E	F	G	H1	H2
I2H1850	115	125	38	100	60-67	Ø6,3	M32/M25	M16
I2H1851	115	125	38	100	60-67	Ø6,3	M32/M25	M16
I3H1850	135	150	38	120	75-90	Ø6,3	M40	M20
I3H1851	135	150	38	120	75-90	Ø6,3	M40	M20

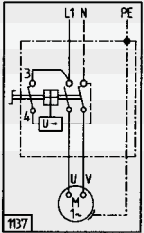
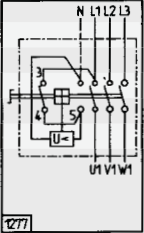
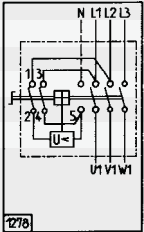
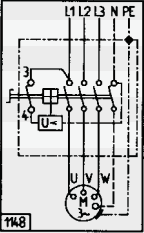
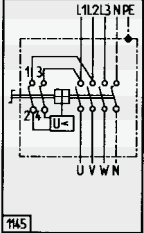
Schaltprogramm Contact arrangement	Dauerstrom I_{th} Rated Uninterrupted current I_{th} A	Leistung Rating AC 3 kW	Leistung Rating AC 23A kW	Baureihe Series	Griff/ Frontschild handle/ front plate	Typ Type	Best.Nr. Part #
2-polig USPA 230V AC 2-pole UVR 230V AC 	25	7,5	11	151/I2H...	rt/ge rd/ye	A 151/1002.I2H1850-U230/N-S	MZ 23 315
	25	7,5	11	151/I2H...	sw/gr bk/gr	A 151/1002.I2H1851-U230/N-S	MZ 23 330
	40	11	15	251/I2H...	rt/ge rd/ye	A 251/1002.I2H1850-U230/N-S	MZ 23 316
	40	11	15	251/I2H...	sw/gr bk/gr	A 251/1002.I2H1851-U230/N-S	MZ 23 331
	63	18,5	22	451/I3H...	rt/ge rd/ye	A 451/1002.I3H1850-U230/N-S	MZ 23 317
	63	18,5	22	451/I3H...	sw/gr bk/gr	A 451/1002.I3H1851-U230/N-S	MZ 23 332
3-polig USPA 230V AC 3-pole UVR 230V AC 	25	7,5	11	151/I2H...	rt/ge rd/ye	A 151/1008.I2H1850-U230/N-S	MZ 23 318
	25	7,5	11	151/I2H...	sw/gr bk/gr	A 151/1008.I2H1851-U230/N-S	MZ 23 333
	40	11	15	251/I2H...	rt/ge rd/ye	A 251/1008.I2H1850-U230/N-S	MZ 23 319
	40	11	15	251/I2H...	sw/gr bk/gr	A 251/1008.I2H1851-U230/N-S	MZ 23 334
	63	18,5	22	451/I3H...	rt/ge rd/ye	A 451/1008.I3H1850-U230/N-S	MZ 23 320
	63	18,5	22	451/I3H...	sw/gr bk/gr	A 451/1008.I3H1851-U230/N-S	MZ 23 335
3-polig USPA 400V AC 3-pole UVR 400V AC 	25	7,5	11	151/I2H...	rt/ge rd/ye	A 151/1008.I2H1850-U400/2S	MZ 23 324
	25	7,5	11	151/I2H...	sw/gr bk/gr	A 151/1008.I2H1851-U400/2S	MZ 23 339
	40	11	15	251/I2H...	rt/ge rd/ye	A 251/1008.I2H1850-U400/2S	MZ 23 325
	40	11	15	251/I2H...	sw/gr bk/gr	A 251/1008.I2H1851-U400/2S	MZ 23 340
	63	18,5	22	451/I3H...	rt/ge rd/ye	A 451/1008.I3H1850-U400/2S	MZ 23 326
	63	18,5	22	451/I3H...	sw/gr bk/gr	A 451/1008.I3H1851-U400/2S	MZ 23 341
4-polig USPA 230V AC 4-pole UVR 230V AC 	25	7,5	11	151/I2H...	rt/ge rd/ye	A 151/1004.I2H1850-U230/N-S	MZ 23 321
	25	7,5	11	151/I2H...	sw/gr bk/gr	A 151/1004.I2H1851-U230/N-S	MZ 23 336
	40	11	15	251/I2H...	rt/ge rd/ye	A 251/1004.I2H1850-U230/N-S	MZ 23 322
	40	11	15	251/I2H...	sw/gr bk/gr	A 251/1004.I2H1851-U230/N-S	MZ 23 337
	63	18,5	22	451/I3H...	rt/ge rd/ye	A 451/1004.I3H1850-U230/N-S	MZ 23 323
	63	18,5	22	451/I3H...	sw/gr bk/gr	A 451/1004.I3H1851-U230/N-S	MZ 23 338
4-polig USPA 400V AC 4-pole UVR 400V AC 	25	7,5	11	151/I2H...	rt/ge rd/ye	A 151/1004.I2H1850-U400/2S	MZ 23 327
	25	7,5	11	151/I2H...	sw/gr bk/gr	A 151/1004.I2H1851-U400/2S	MZ 23 342
	40	11	15	251/I2H...	rt/ge rd/ye	A 251/1004.I2H1850-U400/2S	MZ 23 328
	40	11	15	251/I2H...	sw/gr bk/gr	A 251/1004.I2H1851-U400/2S	MZ 23 343
	63	18,5	22	451/I3H...	rt/ge rd/ye	A 451/1004.I3H1850-U400/2S	MZ 23 329
	63	18,5	22	451/I3H...	sw/gr bk/gr	A 451/1004.I3H1851-U400/2S	MZ 23 344



SCHALTGERÄTE

Komplett-Typen Baureihe MN

Complete types Series MN

Ein-Aus-Schalter
mit **UnterSPannungsAuslösung**

On-Off-Switches
with *UnderVoltageRelease*



im Kunststoffgehäuse

in plastic enclosure

mit Griff schwarz/silber

with handle black/silver

Abmessungen / Dimensions
Bauform / Design: I2H0400 / I3N0400

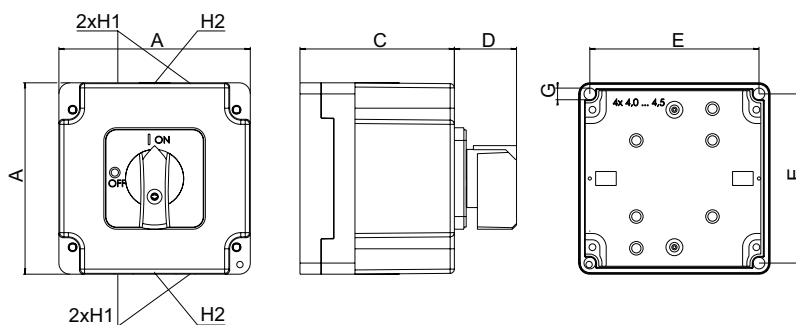

Baureihe Series	Abmessungen (mm) Dimensions (mm)								
	A	C	D	E	F	G	H1	H2	
I2H0400	115	125	31	100	60-67	Ø6,3	M32/M25	M16	
I3N0400	135	150	31	120	75-90	Ø6,3	M40	M20	

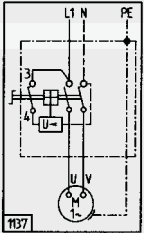
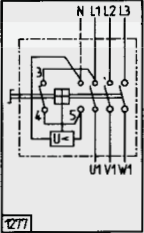
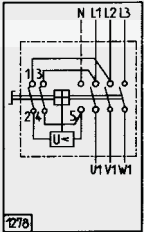
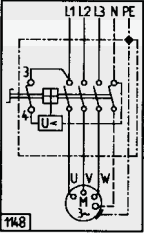
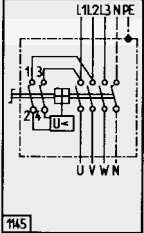
Schaltprogramm Contact arrangement	Dauerstrom I_{th} Rated Uninterrupted current I_{th} A	Leistung Rating AC 3 kW	Leistung Rating AC 23A kW	Baureihe Series	Griff/ Frontschild handle/ front plate	Typ Type	Best.Nr. Part #
2-polig USPA 230V AC 2-pole UVR 230V AC 	25	7,5	11	151/I2H...	sw/si bk/si	A 151/1002.I2H0400-U230/N-S	MZ 23 300
	40	11	15	251/I2H...	sw/si bk/si	A 251/1002.I2H0400-U230/N-S	MZ 23 301
	63	18,5	22	451/I3H...	sw/si bk/si	A 451/1002.I3H0400-U230/N-S	MZ 23 302
3-polig USPA 230V AC 3-pole UVR 230V AC 	25	7,5	11	151/I2H...	sw/si bk/si	A 151/1008.I2H0400-U230/N-S	MZ 23 303
	40	11	15	251/I2H...	sw/si bk/si	A 251/1008.I2H0400-U230/N-S	MZ 23 304
	63	18,5	22	451/I3H...	sw/si bk/si	A 451/1008.I3H0400-U230/N-S	MZ 23 305
3-polig USPA 400V AC 3-pole UVR 400V AC 	25	7,5	11	151/I2H...	sw/si bk/si	A 151/1008.I2H0400-U400/2S	MZ 23 309
	40	11	15	251/I2H...	sw/si bk/si	A 251/1008.I2H0400-U400/2S	MZ 23 310
	63	18,5	22	451/I3H...	sw/si bk/si	A 451/1008.I3H0400-U400/2S	MZ 23 311
4-polig USPA 230V AC 4-pole UVR 230V AC 	25	7,5	11	151/I2H...	sw/si bk/si	A 151/1004.I2H0400-U230/N-S	MZ 23 306
	40	11	15	251/I2H...	sw/si bk/si	A 251/1004.I2H0400-U230/N-S	MZ 23 307
	63	18,5	22	451/I3H...	sw/si bk/si	A 451/1004.I3H0400-U230/N-S	MZ 23 308
4-polig USPA 400V AC 4-pole UVR 400V AC 	25	7,5	11	151/I2H...	sw/si bk/si	A 151/1004.I2H0400-U400/2S	MZ 23 312
	40	11	15	251/I2H...	sw/si bk/si	A 251/1004.I2H0400-U400/2S	MZ 23 313
	63	18,5	22	451/I3H...	sw/si bk/si	A 451/1004.I2H0400-U400/2S	MZ 23 314